











DIRECTIONAL LEDS



3931 SERIES Surface Mount

These versatile LEDs offer a choice of either oval or round shape and surface or grommet mounting. Comprised of 56 high intensity LEDs, these lights feature 15 or 16 flash patterns, and are covered by a 5-year warranty.

Models

PART NO.	SHAPE	TYPE	ILLUMINATION COLOR OPTIONS
3931X		Single	 A  B  C  R
3932X		Single	 A  B  C  R

Replace "X" in part number with desired color: A=Amber, B=Blue, C=Clear, R=Red

Design Features

- 12 VDC
- Extremely thin surface mount design
- Simple three-wire hookup
- Synchronization capable

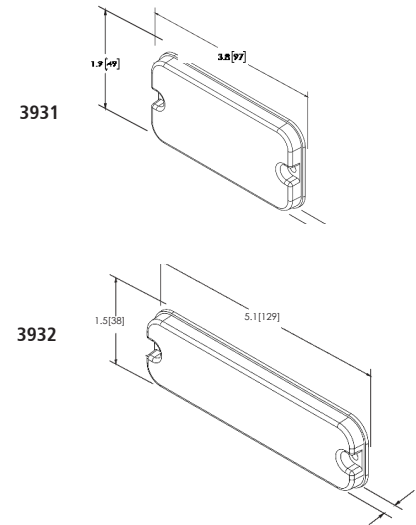

Accessories

- 3931 Black Bezel (A3931BZB)
- 3931 Chrome Bezel (A3931BZC)
- 3932 Black Bezel (A3932BZB)
- 3932 Chrome Bezel (A3932BZC)

