

ROUGH COUNTRY

SUSPENSION SYSTEMS®

TOYOTA 2007-21 Tundra 3" Leveling Kit

Thank you for choosing Rough Country for your suspension needs.

Rough Country recommends a certified technician install this system. In addition to these instructions, professional knowledge of disassembly/reassembly procedures as well as post installation checks must be known. Attempts to install this system without this knowledge and expertise may jeopardize the integrity and/or operating safety of the vehicle.

Please read instructions before beginning installation. Check the kit hardware against the parts list on this page and the product layout on the last page. Be sure you have all needed parts and know where they go. Also please review tools needed list and make sure you have needed tools.

PRODUCT USE INFORMATION

⚠ WARNING As a general rule, the taller a vehicle is, the easier it will roll. Seat belts and shoulder harnesses should be worn at all times. Avoid situations where a side rollover may occur. Generally, braking performance and capability are decreased when larger/heavier tires and wheels are used. Take this into consideration while driving. Do not add, alter, or fabricate any factory or after-market parts to increase vehicle height over the intended height of the Rough Country product purchased. Mixing component brands is not recommended.

Rough Country makes no claims regarding lifting devices and excludes any and all implied claims. We will not be responsible for any product that is altered. If questions exist about the design, function, installation, and correct use of our products please call one of our customer service representatives at 800-222-7023.

This suspension system was developed using a Maximum tire size of 305/65 -18 (33" diameter) tire with factory wheels. For aftermarket wheel and tire combinations consult your tire and wheel specialist.

This kit was designed to level the front of the truck with the rear. This kit includes a strut spacer and strut spacer shim plates to "fine tune" the front with the rear. Before installation is initiated, measure the front and rear of the vehicle to determine how much lift will be needed to level the vehicle. Each shim plate represents approx 3/8" of lift and will be installed on top of the strut spacer as shown in the instruction sheet. (Maximum 2 per side). The spacer alone without shim plates will achieve approx 2 1/4" of lift, can be used without strut spacer shims if desired.

In some cases, the vehicle owner may want the rear of the vehicle lifted also. Rough Country offers an optional 1 1/2" block and u-bolt kit is also available to raise the rear if desired.

⚠ NOTICE NOTICE TO DEALER AND VEHICLE OWNER

Any vehicle equipped with any Rough Country product should have a "Warning to Driver" decal installed on the inside of the windshield or on the vehicle's dash. The decal should act as a constant reminder for whoever is operating the vehicle of its unique handling characteristics.

INSTALLING DEALER - it is your responsibility to install the warning decal and forward these installation instructions on to the vehicle owner for review. These instructions should be kept in the vehicle for its service life.

KIT CONTENT:

2-Front Strut Spacers
 4-Front Strut Spacer Shim Plates
 2-Diff Spacers
 4-Bump-Stop Spacers
 1-Kit Bag that includes:
 8-10mm x 70mm Bolts
 8-10mm Lock Nuts
 8-10mm Flat Washers
 3-8mm x 30mm Bolts
 3-8mm Retaining Washers
 2-9/16" x 6" bolt
 2-9/16 Locknut
 2-9/16 Washer

TOOLS NEEDED:

Hammer
 9/16" Wrench
 13/16" Wrench
 10mm Wrench
 12mm Wrench
 14mm Wrench
 19mm Wrench
 22mm Wrench

TORQUE SPECS

Size	Grade 5	Grade 8
3/8"	30 ft/lbs	35 ft/lbs
9/16"	95 ft/lbs	130 ft/lbs
Metric		
8mm	25ft/lbs	
10mm	42 ft/lbs.	
12mm	70 ft/lbs.	
14mm	95 ft/lbs.	
16mm	200ft./lbs	
18mm	475ft./lbs	



FRONT INSTALLATION

1. Park the vehicle on a level surface and chock the rear wheels.
2. Measure the front / rear to determine how much lift will be needed to level the vehicle. FR _____ RR _____
3. Jack up the front of the vehicle using a floor jack. Place jack stands under the frame rails directly behind the lower control arms and lower the vehicle onto the jack stands.
4. Remove the tires and wheels.
5. Remove the sensor wire bracket as shown in **Photo 1** using a 10MM wrench. **Take care not to overextend or damage this wire.** Retain the hardware for reuse.
6. Remove the upper strut nuts as shown in **Photo 2** using a 14MM wrench. Retain hardware.

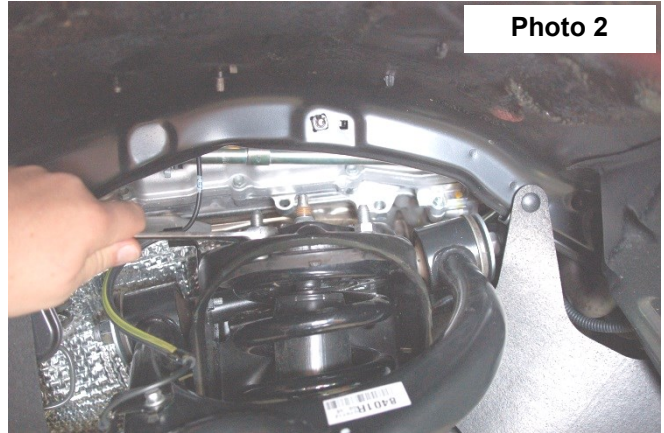
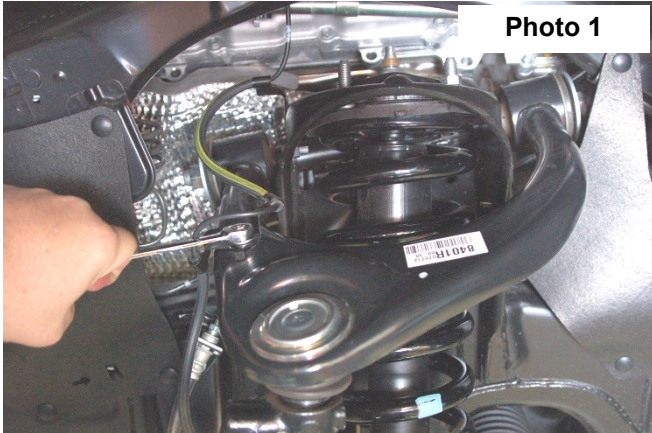

7. Remove the sway bar link from the lower control arms using a 19MM wrench. **See Photo 3.** Retain hardware.
8. Loosen , but do not remove the lower control arm bolts to allow the lower control arm to swing down using a 24MM wrench. **See Photo 4.**

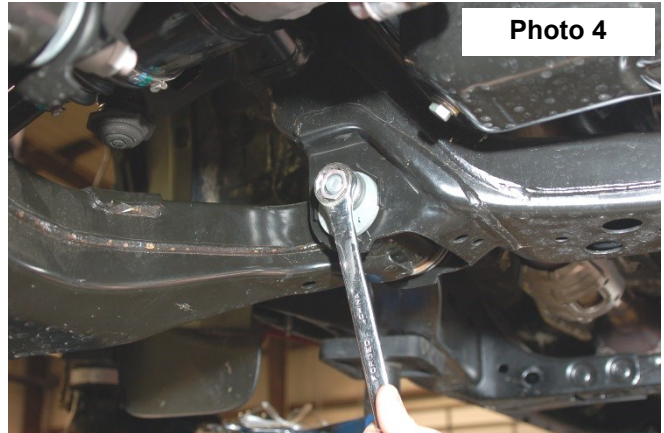
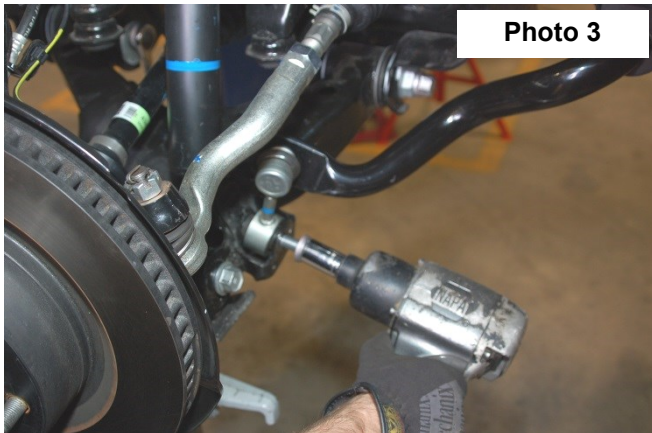

9. Remove the brake line bracket from the knuckle using a 12MM wrench.
10. Remove the upper ball joint nut using a 19MM wrench as shown in **Photo 5**. It may be necessary to hit side of the knuckle to brake the taper lock loose.
11. Remove the lower strut bolts as shown in **Photo 6** using a 22MM socket and wrench. Remove the strut from the vehicle.

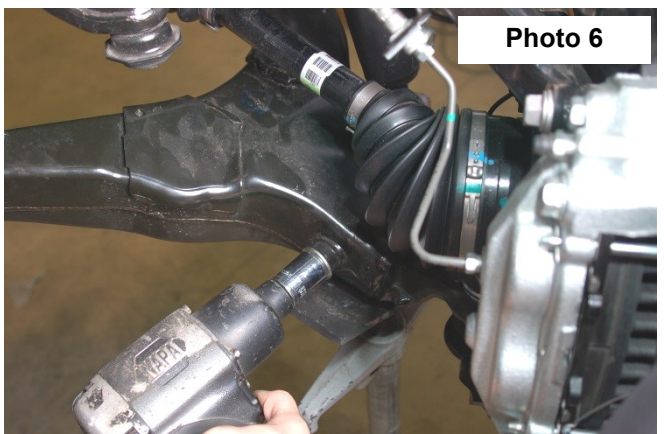
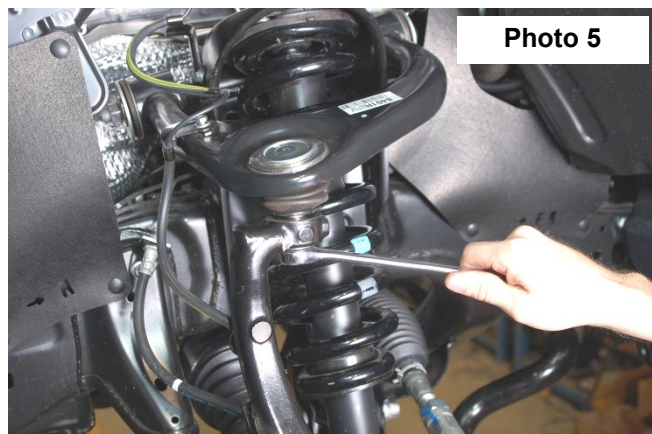

12. Install the supplied 10mm x 70mm bolts through the spacer and then install the spacer to the strut using the stock hardware. Use a paint pen to mark the coil and the top hat at the rubber tab. **See Photo 7.**

13. Place the strut in a strut compressor and clock the spacer about 1" until the notch in the spacer aligns with the mark on the coil. **See Photo 8.**

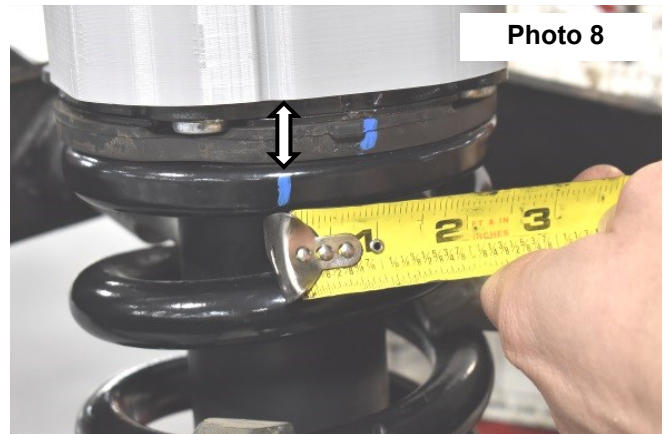
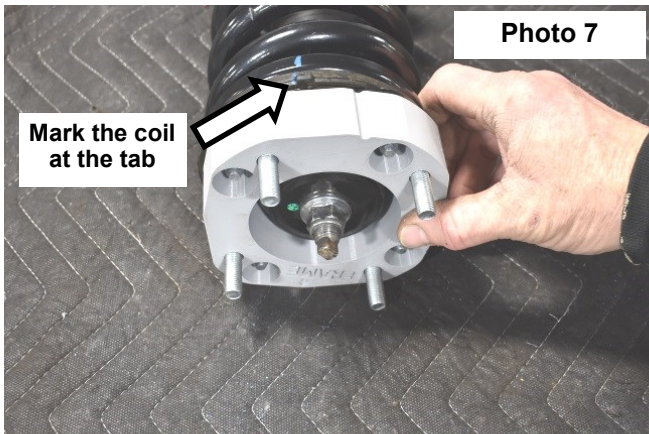

14. On this kit the front of the diff will be lowered to improve axle shaft angle. Remove the front driver as shown in **Photo 9** and passenger side differential bolts.

15. Install the 1" long spacers in between the diff mount and the frame with the supplied 9/16" x 6" hardware. Tighten hardware using a 13/16" wrench. **See Photo 10.**

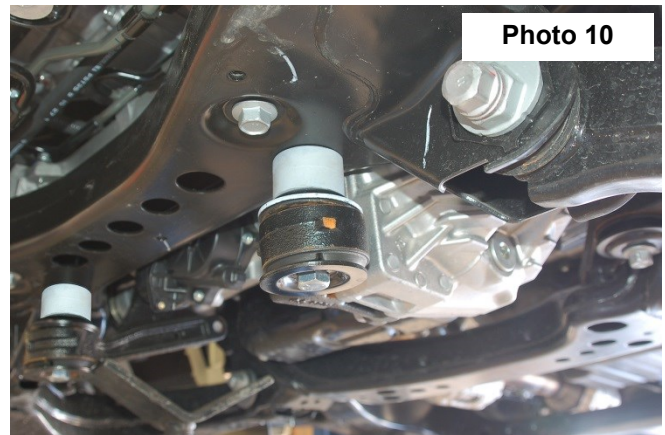
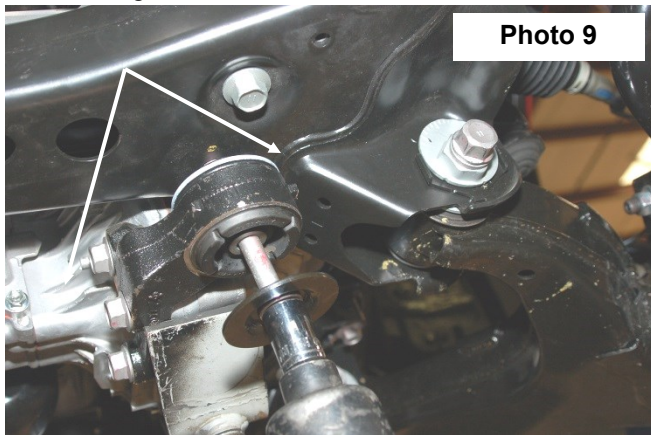

16. Install the shim plates on the strut as shown in **Photo 11**. The shim plates are included to allow the height to be set as needed. If less lift is desired, one or both of the shim plates may be left off the strut spacer and will in turn give less lift. Each spacer shim plate will give approx 3/8" of lift. **Refer to measurement taken in Step 2.**

17. Install the strut in the factory mount with the supplied 10mm lock nuts and flat washers on the upper mount and the factory hardware on the bottom arm. Using a 16mm wrench on the upper and a 22mm socket on the lower mount tighten the hardware.

18. The skid plate spacers will be placed on the skid plate. Using the 8mm x 30mm bolts supplied in the kit, place the bolts through each hole and **secure the bolts with the retaining washers a shown in Photo 12 to keep bolt and spacer in place while installing the skid plate.** Install the skid plate into the stock holes; with the spacers between the skid plate and the frame.

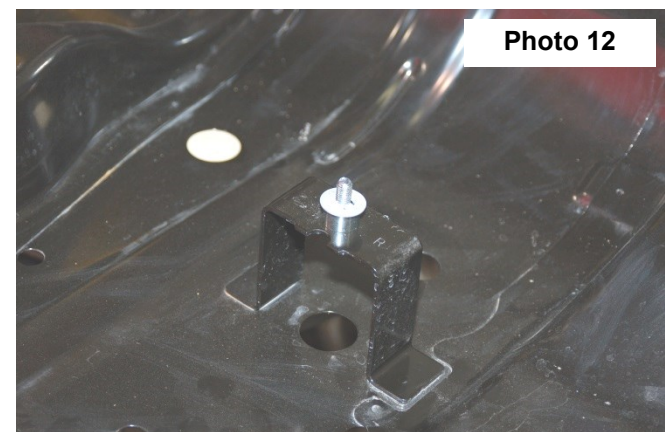
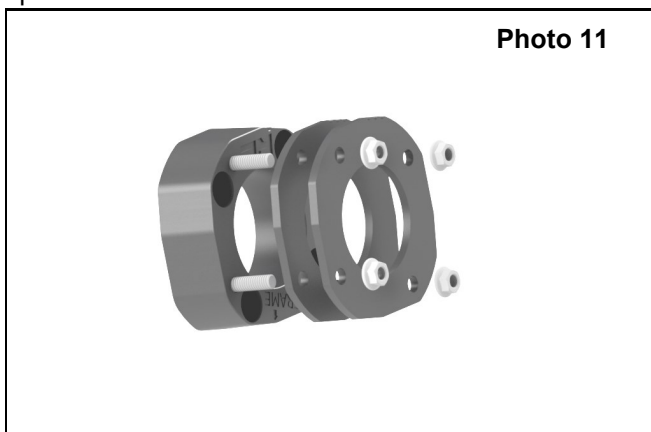

19. Remove the (4) factory bump-stops and install the supplied bump-stop spacers in the factory locations. Then install the factory bump-stops into the spacers. **See Photo 13.**
20. Tighten the bump-stops to factory specs. **See Photo 14.**

