



JEEP JK 1 1/4" 2 / 4 DOOR BODY LIFT KIT

Thank you for choosing Rough Country for your Jeep JK needs.

Rough Country recommends a certified technician installs this system. In addition to these instructions, professional knowledge of disassemble/reassembly procedures as well as post installation checks must be known. Attempts to install this system without this knowledge and expertise may jeopardize the integrity and/or operating safety of the vehicle.

Please read all the instructions before beginning the installation. Check the kit hardware against the parts list. Be sure you have all the needed parts and understand where they go. Also please review the tools needed list and make sure you have needed tools.

KIT CONTENTS:

RC601:

12- RC Body Blocks (4 DOOR KIT)

1—Kit Bag Containing
24—3/8" x 2 1/4" Bolts
24—3/8" Nuts
48—3/8" Washers
Rear Bumper Brackets

RC600:

10- RC Body Blocks (2 DOOR KIT)

1—Kit Bag Containing
20—3/8" X 2 1/4" Bolts
20—3/8" Nuts
40—3/8" Washers
Rear Bumper Brackets

TOOLS NEEDED:

- 18mm Wrench
- 16mm Wrench
- 3/4" Wrench
- 9/16" Wrench & Socket
- Phillips Screw Driver
- Jack Stands
- Wood Block
- Hammer



2DR & 4DR BODY MOUNT LOCATIONS

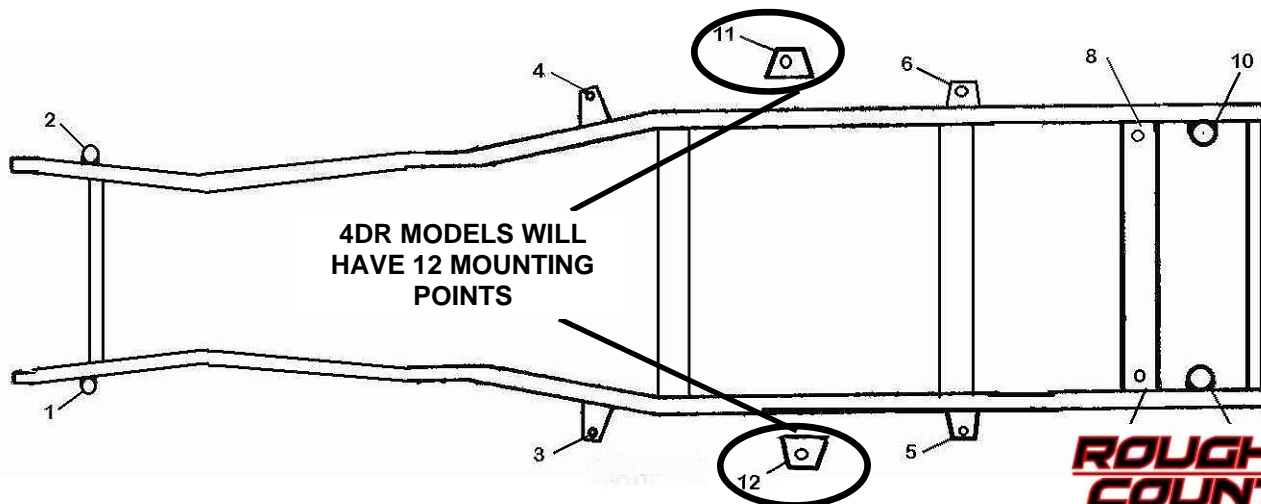

INSTALLATION INSTRUCTIONS FOR JEEP JK 2 AND 4 DOOR BODY LIFT

1. Place Jeep on clean, dry, level surface. Installation is done one side at a time.
2. Raise hood. Using a Phillips screw driver, remove the (6) push pin inserts from grill on top side as shown. Retain for re-use. **See Photo 1.**
3. Pull grill toward you to release the three lower clips. **See Photo 2.**



4. Disconnect the parking light electrical connector and remove grill assembly. **See Photo 3.**
5. Using a 16mm wrench remove the 2 stud nuts from the stock body mounts as shown (12 mounts for 4 door and 8 mounts for 2 door), removing only the passenger side first. **See Photo 4.**

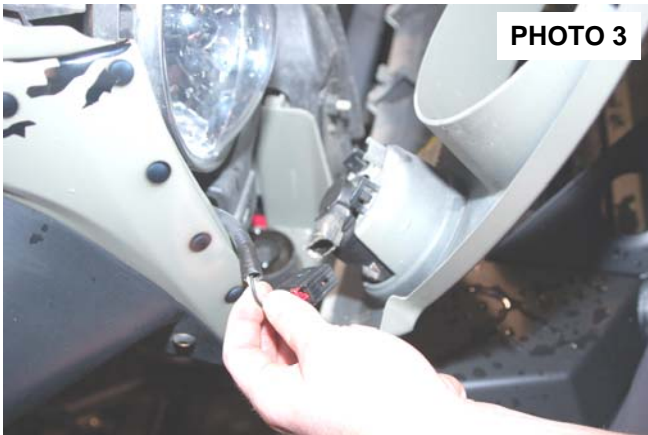

6. After completion of removing the stud nuts, remove the center stud bolt and washer from the passenger side body mounts using a 18mm wrench. **See Photo 5**
7. After all isolator nuts and center mounting bolts are removed from the passenger side, position a wood block and (2) jack stands under the body as shown. Lift the body upwards and begin removing the body mounts. **See Photo 6.**



8. After removing the stock body mounts from your vehicle, replace the nut on the stud and tighten the nut only until the stud thread and nut are even. Using a 3/4" wrench and hammer, place the head side of the stud inside the wrench and then place onto a flat surface. Strike the nut side of the stud until the stud releases. Proceed with stud removal of all body mounts. **See Photo 7.**
9. After stud removal is complete, place the Rough Country body block onto the stock mount as shown. **See Photo 8.**



10. Re-install the body mount using the 3/8" x 2 1/4" bolt / washers and nuts supplied. Secure these bolts into place using a 9/16 wrench and tighten to 40ft/lbs. Note: The RC block will mount towards the body on the front two mounts. On the rear mounts, the RC block will mount to the frame side. **See Photo 9 & 10. With the addition of the body spacer the factory body mount bolt washers on the two rear-most body mounts may come in contact with the supplied 3/8" hardware creating a squeaking or popping. If needed slightly grind the factory body mount washer to clear the supplied 3/8" hardware. See Photo 11.**

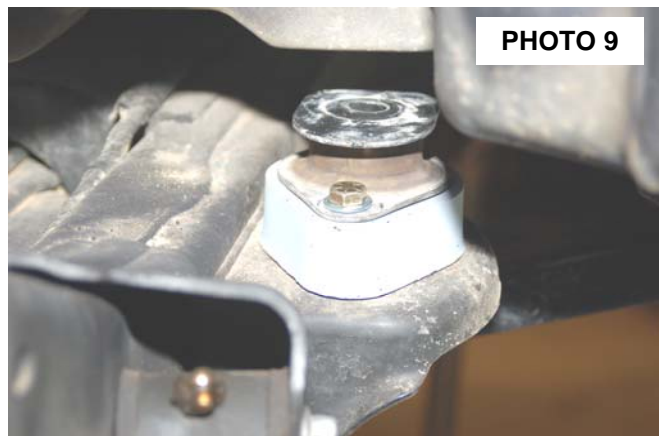

11. Lower the jacks so that body mount meets with the frame mount and remove the jacks.
12. Using a 18mm wrench secure center mounting bolts, only hand tight.
13. Repeat all above steps to driver side.
14. After completion of installing all body blocks and mounts, completely remove jacks and wood block. Using an 18mm wrench torque center mounting bolts to 80 ft/lbs on all body mounts.
15. Reattach grill parking light electrical connectors. Snap grill into lower clips and using a Philips screw driver, secure the grill with the factory pin fasteners (6) on the top side.
16. Close hood. Recheck torque after 500 miles on all bolts. The 3/8" bolts should be 40ft/lbs and the stock mounting bolts should be at 80ft/lbs.

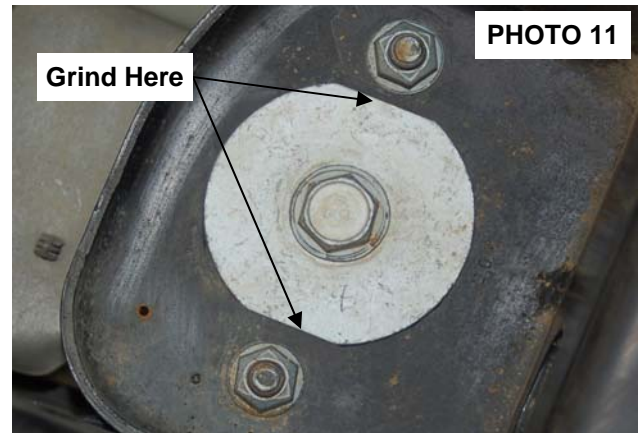
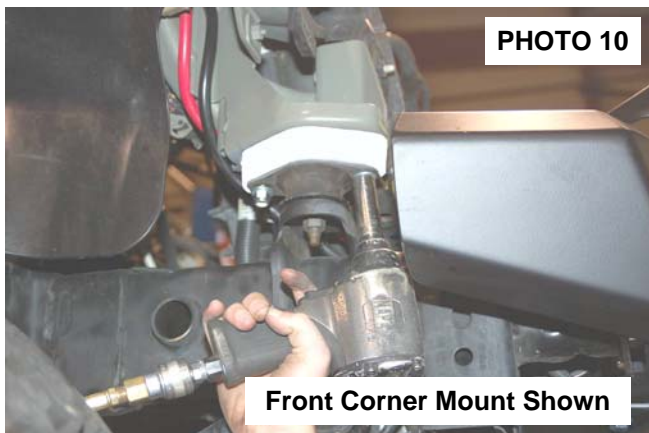

REAR BUMPER BRACKET INSTALLATION INSTRUCTIONS

1. Remove the stock bumper brackets from the frame rail and the bumper as shown in **Photo 1 & 2** using a 16mm socket.

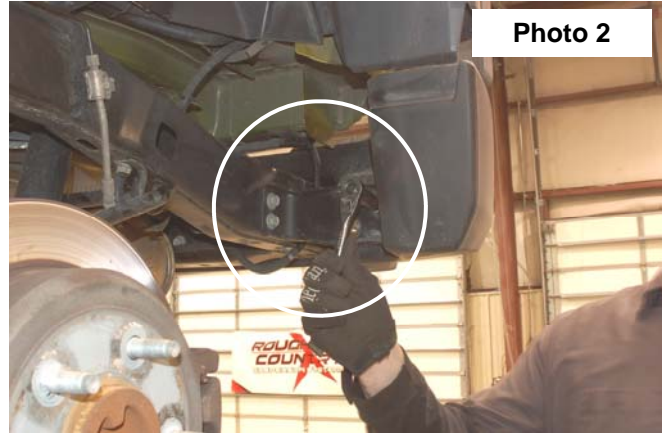
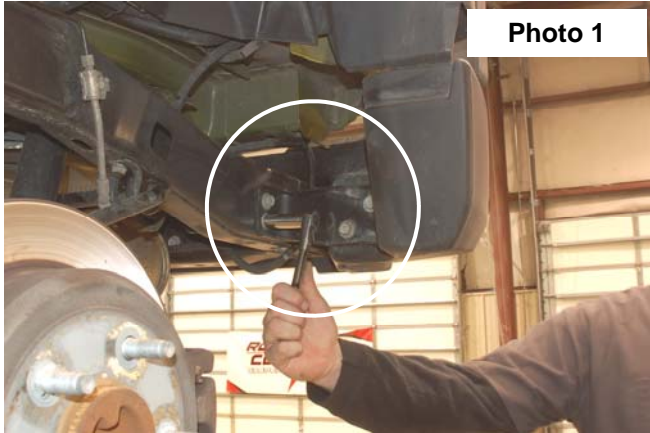

2. Remove the inner brackets from the frame rail as shown in **Photo 3** from the driver and passenger side. Retain the hardware for reuse.
3. Remove the stock bumper from the vehicle.
4. Install the inner bumper brackets on the bumper as shown in **Photo 4** using stock hardware. Do not tighten at this time.

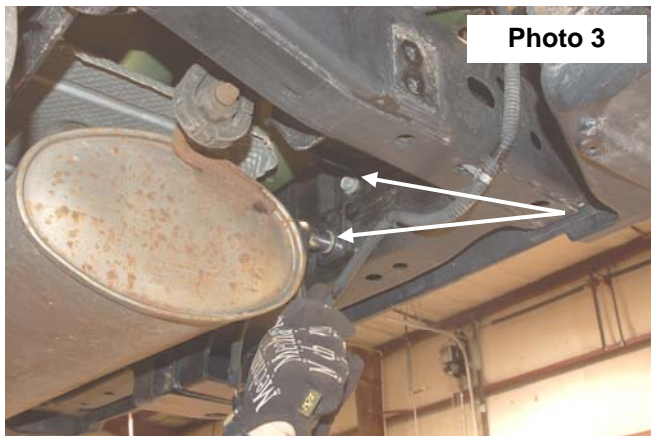

5. Install the bumper on the frame and install the outer bumper brackets with the stock hardware. Do not tighten at this time. **See Photo 5.**
6. Align the bumper and tighten all hardware with a 16mm socket. **See Photo 6.**

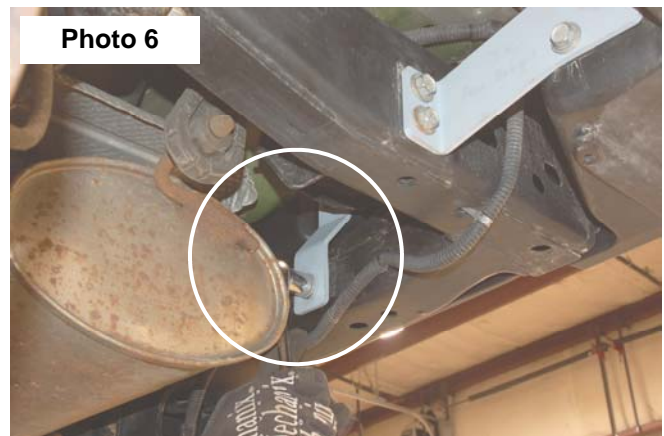
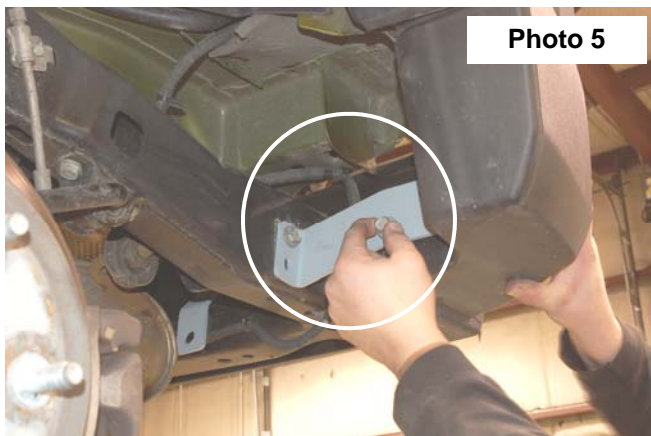

POST INSTALLATION

1. Check all fasteners for proper torque. Check to ensure there is adequate clearance between all rotating, mobile, fixed and heated members. Check steering for interference and proper working order.
2. Re torque all fasteners after 500 miles. Visually inspect components and re torque fasteners during routine vehicle service.

Thank you for choosing Rough Country for your Jeep off road needs.